

Active Transmitter Combiner 8:1 AC 3200



Contents

Important safety instructions	2
The AC 3200 active transmitter combiner 8:1	5
Delivery includes	5
Connection diagram	6
Product overview	7
Putting the AC 3200 into operation	8
Preparing the AC 3200 for use	8
Connecting the antenna	10
Connecting a transmitter to the AC 3200	10
Connecting the mains cable	11
Switching the AC 3200 on and off	11
Recommendations and tips for optimum reception	12
Cleaning the AC 3200	12
If a problem occurs	13
Accessories and spare parts	14
Specifications	15
Manufacturer Declarations	16

Important safety instructions

1. Read these instructions.
2. Keep these instructions. Always include these instructions when passing the device on to third parties.
3. Heed all warnings.
4. Follow all instructions.
5. Do not use the device near water.
6. Clean only with a dry cloth.
7. Do not block any ventilation openings. Install in accordance with these instructions.
8. Do not install near any heat sources such as radiators, heat registers, stoves, or other devices (including amplifiers) that produce heat.
9. The device should be operated only from the type of power source indicated on the mains plug. The device must only be connected to properly grounded power outlets.
10. Protect the mains cable from being walked on or pinched, particularly at plugs, convenience receptacles, and the point where it exits from the device.
11. Only use attachments/accessories specified by Sennheiser.
12. Use only with the cart, stand, tripod, bracket, or table specified by the manufacturer, or sold with the device. When a cart is used, use caution when moving the cart/apparatus combination to avoid injury from tip-over.
13. Unplug the device during lightning storms or when unused for long periods of time.
14. Refer all servicing to qualified service personnel.
Servicing is required if the device has been damaged in any way, such as mains cable or plug damage, liquid has been spilled, objects have fallen inside, the device has been exposed to rain or moisture, does not operate properly or has been dropped.
15. To completely disconnect the device from the AC mains, disconnect the mains plug from the AC receptacle.
16. **WARNING:** To reduce the risk of fire or electric shock, do not expose the device to rain or moisture.
17. Do not expose the device to dripping or splashing and ensure that no objects filled with liquids, such as vases or coffee cups, are placed on the device.
18. The plug of the mains cable shall remain readily operable and easily accessible.



Hazard warnings on the rear of the AC 3200 active transmitter combiner 8:1



The label shown on the left is attached to the rear of the AC 3200. The symbols on this label have the following meaning:



This symbol is intended to alert the user to the presence of uninsulated dangerous voltage within the AC 3200's enclosure that may be of sufficient magnitude to constitute risk of fire or electric shock.



This symbol is intended to alert the user to the risk of electric shock if the AC 3200 is opened. There are no user serviceable parts inside. Refer servicing to qualified personnel only.



This symbol is intended to alert the user to the presence of important operating and maintenance instructions in the literature accompanying this AC 3200.

Overloading

Do not overload wall outlets and extension cables as this may result in fire and electric shock.

Replacement parts

When replacement parts are required, be sure the service technician has used replacement parts specified by Sennheiser or those having the same characteristics as the original part. Unauthorized substitutions may result in fire, electric shock, or other hazards.

Safety check

Upon completion of any service or repairs to this device, ask the service technician to perform safety checks to determine that the device is in a safe operating condition.

Intended use of the device

Intended use of the AC 3200 includes:

- using the device for professional purposes,
- having read this instruction manual especially the chapter “Important safety instructions” on page 2,
- using the device within the operating conditions and limitations described in this instruction manual.

“Improper use” means using the device other than as described in this instruction manual, or under operating conditions which differ from those described herein.

The AC 3200 active transmitter combiner 8:1

With the AC 3200 active transmitter combiner, the signals of up to eight Sennheiser wireless monitoring transmitters can be combined onto a single antenna, e.g. the A 2003 UHF directional antenna, the A 1031 U omni-directional antenna or the A 5000 CP circularly polarized UHF antenna. For suitable transmitters, please refer to the AC 3200 product page at www.sennheiser.com.

The AC 3200 allows you to make high-quality 8-channel transmission systems suitable for the following areas of application:

- Multi-channel monitoring systems for stage use
- Multi-channel systems suitable for any application where talk-back signals are to be transmitted (e.g. studio)

Delivery includes

- 1 AC 3200 active transmitter combiner 8:1
- 3 mains cable (EU/UK/US)
- 4 self-adhesive device feet
- 1 instruction manual

Connection diagram

The below connection diagram shows the connections for an 8-channel system with a single antenna.

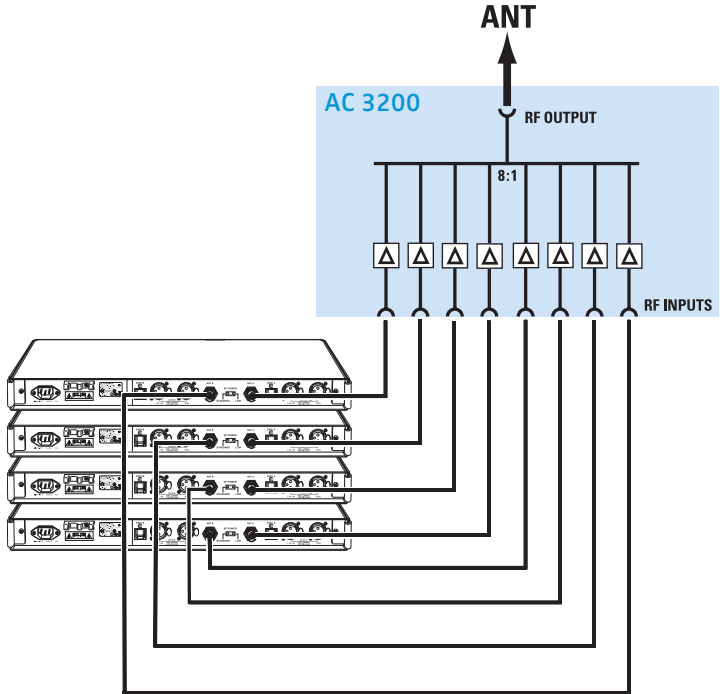

Product overview

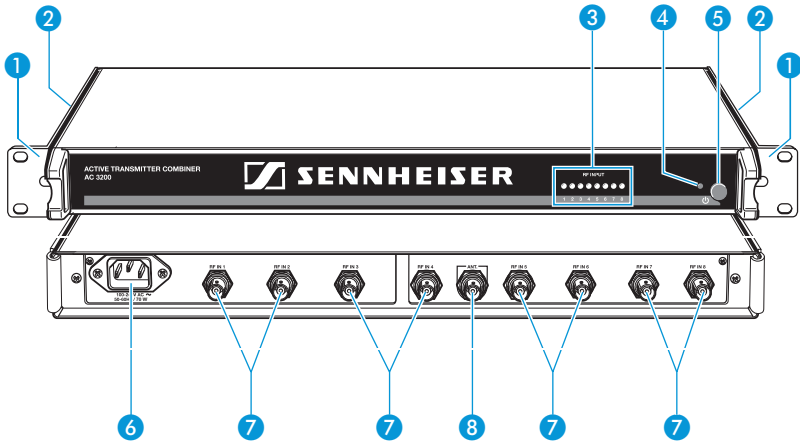

- 1 Rack mount "ears"
- 2 Air vents (on the sides)
- 3 8 LEDs: operation indicators of the RF inputs
- 4 LED $\text{\textcircled{P}}$
- 5 On/off switch $\text{\textcircled{P}}$
- 6 IEC mains socket
- 7 8 RF inputs **RF IN 1** to **RF IN 8** for connecting the transmitters
- 8 BNC socket for antenna output **ANT**

Putting the AC 3200 into operation

Preparing the AC 3200 for use

You can set up the AC 3200 on an even surface or mount it into a 19" rack.

Setting up the device

CAUTION! Danger of heat damage to the devices!



During operation, the AC 3200 and the connected transmitters produce considerable waste heat! If this heat cannot dissipate, it can cause damage to the devices!

The devices are equipped with fans to assist dissipation of generated heat:

- ▶ Make sure that the air vents ② on the sides of the AC 3200 are not covered or blocked and provide ducts of sufficient size or allow sufficient space to ensure a free air flow between the devices.
- ▶ Regularly clean the air vents on the sides of the AC 3200 with a soft brush.
- ▶ In order to avoid heat accumulation, make sure to install the AC 3200 as the uppermost device.
- ▶ Never stack more than two devices directly one above the other!

To ensure that the AC 3200 cannot slip on the surface on which it is placed, four self-adhesive soft rubber feet are supplied.

CAUTION! Risk of staining of surfaces!



Some surfaces have been treated with varnish, polish or synthetics which might cause stains when they come into contact with other synthetics. Despite a thorough testing of the synthetics used by us, we cannot rule out the possibility of staining.

- ▶ Do not place the AC 3200 on delicate surfaces.
-

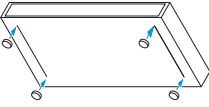

- ▶ Ensure that the base of the AC 3200 is clean and free from grease before fitting the rubber feet.
- ▶ Fix the rubber feet to the base of the AC 3200 by peeling off the backing paper and fitting them as shown in the diagram on the left.
- ▶ Place the AC 3200 on an even, horizontal surface.

Rack-mounting

CAUTION! Risks when rack mounting the AC 3200!



When installing the device in a closed or multi-rack assembly, please consider that, during operation, the ambient temperature, the mechanical loading and the electrical potentials will be different from those of devices which are not mounted into a rack.

- ▶ The ambient temperature within the rack must not exceed the temperature limit specified in the AC 3200 specifications.
- ▶ When installing the device in a rack, take good care not to affect the ventilation required for safe operation. If necessary, provide additional ventilation.
- ▶ In order to avoid heat accumulation, make sure to install the AC 3200 as the uppermost device in the rack.
- ▶ Provide for a duct or vent space of 1 U above the AC 3200 to ensure that the heated air can dissipate.
- ▶ Make sure the mechanical loading of the rack is even to avoid a hazardous condition such as a severely unbalanced rack.
- ▶ When connecting the device to the power supply, observe the information indicated on the type plate. Avoid circuit overloading. If necessary, provide overcurrent protection.
- ▶ Ensure a reliable mains ground connection of the device by taking appropriate measures.
- ▶ When installing the device in a closed or multi-rack assembly, please note that intrinsically harmless leakage currents of the individual devices may accumulate, thereby exceeding the allowable limit value. As a remedy, ground the rack via an additional ground connection.

To mount the AC 3200 into a 19" rack:

- ▶ Slide the AC 3200 into the 19" rack.
- ▶ Secure the rack mount "ears" ① to the rack using four screws (not included).

Connecting the antenna

CAUTION! Danger of damage to the devices!



Do **not** daisy-chain several AC 3200. Do **not** connect other active combiners to the AC 3200.

- ▶ Never connect the AC 3200 to other active combiners.
- ▶ Only connect suitable antennas to the output of the AC 3200!

The AC 3200 active transmitter combiner can be used with either the A 2003 UHF directional antenna, the A 1031 U omnidirectional antenna or the A 5000 CP circularly polarized UHF antenna. The antenna transmits the signals of all connected transmitters (see page 12).

The signals are combined onto the antenna output with no distribution attenuation.

To connect an antenna:

- ▶ Connect the antenna using a low-attenuation 50 Ω coaxial cable.
- ▶ Connect the coaxial cable to the antenna output ⑧.

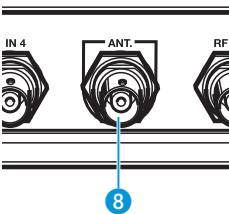

Connecting a transmitter to the AC 3200

To connect a transmitter:

- ▶ Connect the BNC cable of the transmitter to one of the eight RF inputs RF IN 1 to RF IN 8 ⑦.

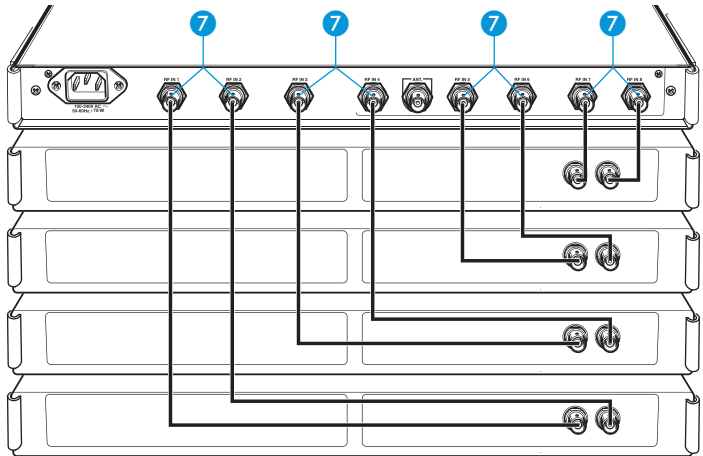

Connecting the mains cable

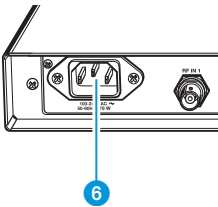

- ▶ Connect the suitable mains cable to the IEC mains socket 6 and to the mains.

Note:

The AC 3200 can be connected to any mains power supply with 100 V to 240 V AC (50 to 60 Hz).

Switching the AC 3200 on and off

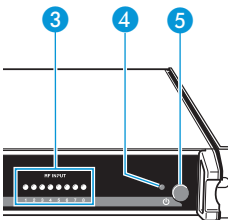

- ▶ Press the on/off switch 5. The AC 3200 switches on and the LED 4 lights up red.
- ▶ Press the on/off switch 5 again. The AC 3200 switches off and the LED 4 goes off.

Note:

After switch-off, the AC 3200 is in standby mode. To disconnect the device from the mains, pull out the mains connector from the wall socket.

RF indicators

The AC 3200 has eight control LED 3 which light up on the channels where transmission power is available.

Recommendations and tips for optimum reception

- There should be a “free line of sight” between transmitting and receiving antennas.
- To avoid overloading the receiver, observe a minimum distance of 5 m between transmitting and receiving antennas.
- Observe a minimum distance of 50 cm between the transmitting antenna and metal objects (such as cross members or reinforced-concrete walls).
- When using a multi-channel system:
Set all transmitters of your multi-channel system to intermodulation-free frequencies.

Cleaning the AC 3200

CAUTION!

Liquids can damage the electronics of the device!









Liquids entering the housing of the device can cause a short-circuit and damage the electronics.

- ▶ Keep all liquids away from the device.
- ▶ Do not use any solvents or cleansing agents.

-
- ▶ Before cleaning, disconnect the device from the mains.
 - ▶ Only use a slightly damp cloth to clean the device.
 - ▶ Regularly check the air vents for dust deposits. If necessary, remove the dust with a soft brush.

If a problem occurs ...

Problem	Possible cause	Possible solution
The LED  4 does not light up	The AC 3200 doesn't consume current	Check if the AC 3200 is connected to the mains and if the on/off switch  5 is pressed
Extra LEDs  3 light up for RF inputs which are not in use	The transmitting antenna is not connected, the transmitting antenna is faulty or the wrong type, the cable to the transmitting antenna is damaged, faulty, or of the wrong type	Check that the transmitting antenna is correctly connected, is not damaged, and that the connecting cable is undamaged and is of the correct type.
		Check that the transmitting antenna is connected to the antenna output  8 and that all transmitters are connected to RF inputs  7
One or several LEDs  3 do not light up	A transmitter is connected to the respective input but is switched off	Switch the transmitter on
Disturbed reception or no reception	The transmitting antenna is not within the reception area	Reduce the distance between transmitter and receiver
	The receiver batteries are not inserted or batteries are low	Replace the receiver batteries
	The antenna is not connected correctly	Check if the antenna is connected correctly
	Too high cable attenuation due to too long antenna cables or wrong type of antenna cable	Use a shorter antenna cable or the correct type of antenna cable
		Use low-attenuation 50 Ω coaxial cable
Interference or intermodulation during multi-channel operation	Set all transmitters of your multi-channel system to intermodulation-free frequencies	

If a problem occurs that is not listed in the above table or if the problem cannot be solved with the proposed solutions, please contact your local Sennheiser agent for assistance.

Accessories and spare parts

The following accessories are available from your Sennheiser partner:

Cat. No. **Accessory/spare part**

- 003658** A 2003 UHF passive directional antenna
- 004645** A 1031 U passive omni-directional antenna
- 500887** A 5000 CP circularly polarized UHF antenna
- 002324** GZL 1019-A1 BNC-BNC coaxial cable, type RG 58, length 1 m

Specifications

Frequency range	500 – 870 MHz
Distribution attenuation	0 dB (± 1 dB)
RF input power	
nominal value	up to 100 mW per input
inputs protected up to	max. 250 mW
Impedance	50 Ω
Power supply	100 V – 240 V AC, 50 – 60 Hz
Power consumption	max. 70 W
Temperature range	0 °C to 45 °C
Weight	approx. 4 kg

Type approvals

Area	Conformity
USA:	FCC-Part 74.861
	FCC ID: DMOAC3200 / limited to 698 MHz!
Canada:	RSS-123
	IC: 2099A-AC3200
EU:	CE 0682 
	complies with the requirements for radio and EMC (R&TTE):
	<ul style="list-style-type: none"> • EN 300422-1/-2 • EN 300454-1/-2 • EN 301489-1/-9
	complies with the requirements for safety (LVD):
	<ul style="list-style-type: none"> • EN 60065

Manufacturer Declarations

Warranty

Sennheiser GmbH & Co. KG gives a warranty of 24 months on this product.

For the current warranty conditions, please visit our web site at www.sennheiser.com or contact your Sennheiser partner.

CE Declaration of Conformity

CE 0682 

This equipment is in compliance with the essential requirements and other relevant provisions of Directives 1999/5/EC and 2006/95/EC. The declaration is available on the internet site at www.sennheiser.com.

Before putting the equipment into operation, please observe the respective country-specific regulations!

Statements regarding FCC and industry Canada

This device complies with Part 15 of the FCC Rules and with RSS-210 of Industry Canada. Operation is subject to the following two conditions: (1) this device may not cause harmful interference, and (2) this device must accept any interference received, including interference that may cause undesired operation.

This equipment has been tested and found to comply with the limits for a Class B digital device, pursuant to Part 15 of the FCC Rules. These limits are designed to provide reasonable protection against harmful interference in a residential installation. This equipment generates, uses and can radiate radio frequency energy and, if not installed and used in accordance with the instructions, may cause harmful interference to radio communications. However, there is no guarantee that interference will not occur in a particular installation. If this equipment does cause harmful interference to radio or television reception, which can be determined by turning the equipment off and on, the user is encouraged to try to correct the interference by one or more of the following measures:

- Reorient or relocate the receiving antenna.
- Increase the separation between the equipment and receiver.
- Connect the equipment into an outlet on a circuit different from that to which the receiver is connected.
- Consult the dealer or an experienced radio/TV technician for help.

Changes or modifications made to this equipment not expressly approved by Sennheiser electronic Corp. may void the FCC authorization to operate this equipment. Before putting the device into operation, please observe the respective country-specific regulations!



Sennheiser electronic GmbH & Co. KG
Am Labor 1, 30900 Wedemark, Germany

Phone: +49 (5130) 600 0

Fax: +49 (5130) 600 300

www.sennheiser.com

Printed in Germany

Publ.09/08

528244/A01